



# Python® Series Pumps

Pneumatically Operated Pumps for Chemical Injection



MJ Systems, LLC  
Authorized Graco Distributors  
TX - Off (281) 842-7600  
LA - Off (504) 264-7744  
www.mjsusa.com • sales@mjsusa.com



PROVEN QUALITY. LEADING TECHNOLOGY.

# Python® Pneumatically Operated Pumps

Python pumps are ideal for applications that require a pump to operate in a potentially explosive atmosphere and can run off regulated natural gas or compressed air. These pumps have the lowest out of pocket cost, are easy to operate and use half the air consumption of other pumps in the market. Plus, the Python's extreme duty plungers, seals and timing valve are designed for years of operation before replacement.

## Ease of serviceability

- Easy access to the pump plunger and packings
- Cartridge style seal in the timing valve for quick and easy repair
- Plunger packings can quickly be replaced

## Highest technology timing valve on the market

- Low air/gas consumption for increased efficiency
- Pump cycle rate remains constant regardless of system back pressure

## Robust and simple design

- Adjustable fluid packing lasts up to 25 times longer than non-adjustable seals
- Pythons are offered with Chromex and Ceramic coated plungers
- 316 SST fluid section/wetted parts
- HNBR, FKM, FKM ETP, TFEP and FFKM plunger packings and check valve seals
- Proprietary poppet style check valve eliminates valve from sticking

## Ordering Information

GRACO Python Pneumatically Operated Pumps							
Seals / Plunger Size	1/8"	3/16"	1/4"	3/8"	1/2"	5/8"	3/4"
<b>1.25" Air Piston (CE Approved)</b>							
FKM	A25000	A25001	A25002	A25003	A25004	A25005	A25006
FKM-ETP	A25021	A25022	A25023	A25024	A25025	A25026	A25027
HNBR	A25042	A25043	A25044	A25045	A25046	A25047	A25048
FFKM	A25063	A25064	A25065	A25066	A25067	A25068	A25069
TFE/P	A25090	A25091	A25092	A25093	A25094	A25095	A25096
<b>1.75" Air Piston (CE Approved)</b>							
FKM	A25007	A25008	A25009	A25010	A25011	A25012	A25013
FKM-ETP	A25028	A25029	A25030	A25031	A25032	A25033	A25034
HNBR	A25049	A25050	A25051	A25052	A25053	A25054	A25055
FFKM	A25070	A25071	A25072	A25073	A25074	A25075	A25076
TFE/P	A25097	A25098	A25099	A25184	A25185	A25186	A25187
TFE/P (U-cup)	—	—	A25084	A25085	A25086	—	—
<b>2" Air Piston (CE Approved)</b>							
FKM	A25014	A25015	A25016	A25017	A25018	A25019	A25020
FKM-ETP	A25035	A25036	A25037	A25038	A25039	A25040	A25041
HNBR	A25056	A25057	A25058	A25059	A25060	A25061	A25062
FFKM	A25077	A25078	A25079	A25080	A25081	A25082	A25083
TFE/P	A25188	A25189	A25190	A25191	A25192	A25193	A25194
TFE/P (U-cup)	—	—	A25087	A25088	A25089	—	—

<b>1.25" Air Piston (ATEX Approved)</b>							
FKM	A25100	A25101	A25102	A25103	A25104	A25105	A25106
FKM-ETP	A25121	A25122	A25123	A25124	A25125	A25126	A25127
HNBR	A25142	A25143	A25144	A25145	A25146	A25147	A25148
FFKM	A25163	A25164	A25165	A25166	A25167	A25168	A25169
<b>1.75" Air Piston (ATEX Approved)</b>							
FKM	A25107	A25108	A25109	A25110	A25111	A25112	A25113
FKM-ETP	A25128	A25129	A25130	A25131	A25132	A25133	A25134
HNBR	A25149	A25150	A25151	A25152	A25153	A25154	A25155
FFKM	A25170	A25171	A25172	A25173	A25174	A25175	A25176
<b>2" Air Piston (ATEX Approved)</b>							
FKM	A25114	A25115	A25116	A25117	A25118	A25119	A25120
FKM-ETP	A25135	A25136	A25137	A25138	A25139	A25140	A25141
HNBR	A25156	A25157	A25158	A25159	A25160	A25161	A25162
FFKM	A25177	A25178	A25179	A25180	A25181	A25182	A25183

## Standards



ATEX Approved Python Pump

# Performance Curves

KEY	
Inlet Pressure	
A	= 50 psi (3.5 bar)
B	= 100 psi (6.9 bar)
C	= 150 psi (10.3 bar)
D	= 200 psi (13.8 bar)

## 1 1/4" Air Motors (PCI-125)

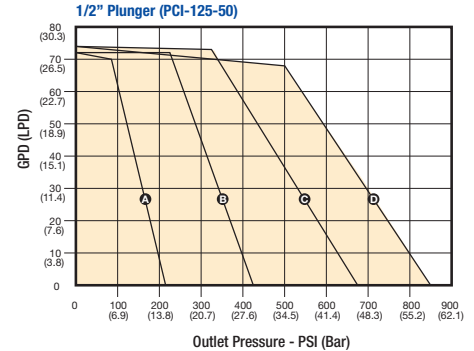
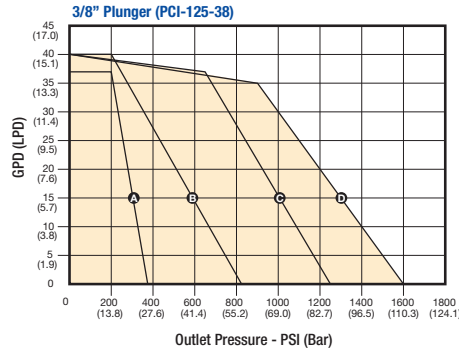
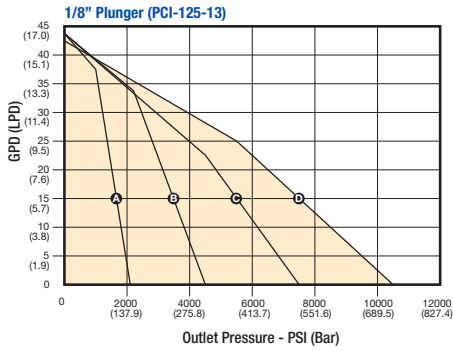

## 1 3/4" Air Motors (PCI-175)

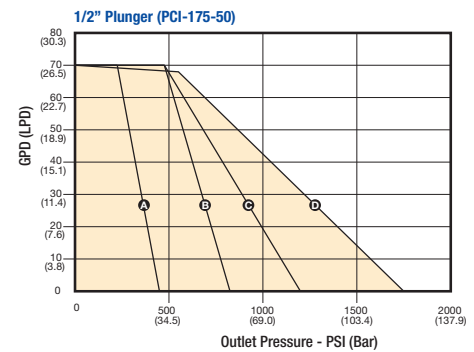
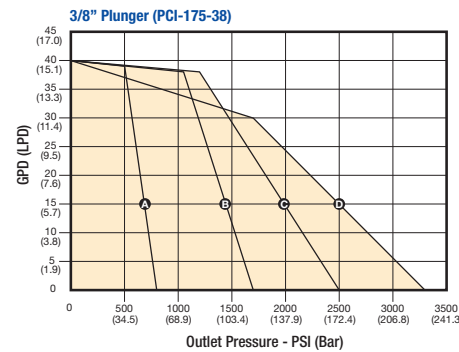
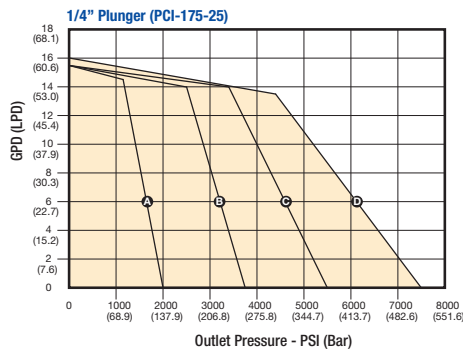

## 2" Air Motors (PCI-200)

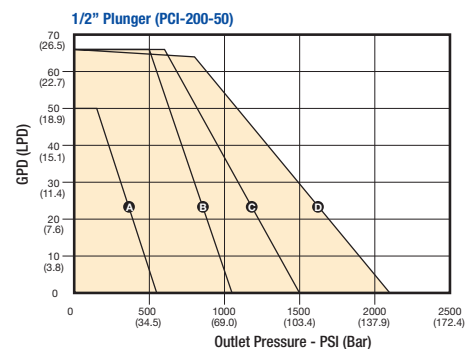
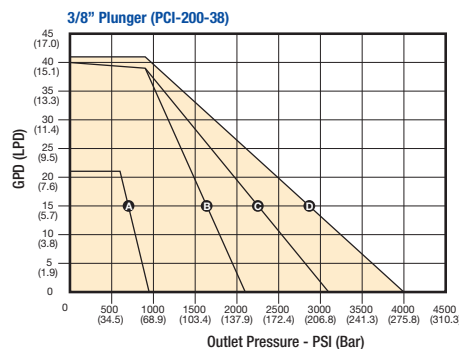
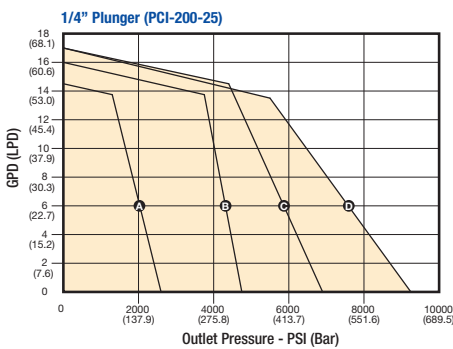

**Note:** Please see instruction manual for different plunger sizes.

# Python® XL Pneumatically Operated Pumps

## Features and Benefits

Python XL series pumps are ideal for wells with low gas pressure. Capable of operating up to 12,000 psi, the pumps are easy to operate and include an air motor with the same proven technology that Graco offers in other product lines. Plus the Python XL's extreme duty plungers (Chromex™ and ceramic coated), seals and air valves are designed for years of operation before replacement.

### Ease of serviceability

- Modular air valve design
- Removable pilot valve
- Pump lowers are interchangeable with other Python XL models
- Plunger packings can be replaced in 10 minutes or less

### Highest technology air motor on the market

- Only requires a minimum of 15 psi to operate pump
- Low air/gas consumption for increased efficiency
- Muffler provides low operation noise levels
- Proven Graco® Merkur® air motor technology

### Robust and simple design

- 316 SST fluid section/wetted parts
- Three stroke adjustment positions
- HNBR, FKM, FKM ETP, FFKM, and TFE/P plunger packings and check valve seals

### Environmentally friendly

- 97% recoverable exhaust gas
- Reduced fugitive methane emissions

#### Needle/Blow Off Valve

Helps control pump stroke speed and protects against over-pressure

#### Air Valve

Provides smooth and rapid changeover

#### Pump Stroke Adjustment

Three position stroke adjust

#### Adjustable Packing Seals

For better sealing and increased pump life

#### Pump Plunger Rod

Available in Chromex and ceramic coatings

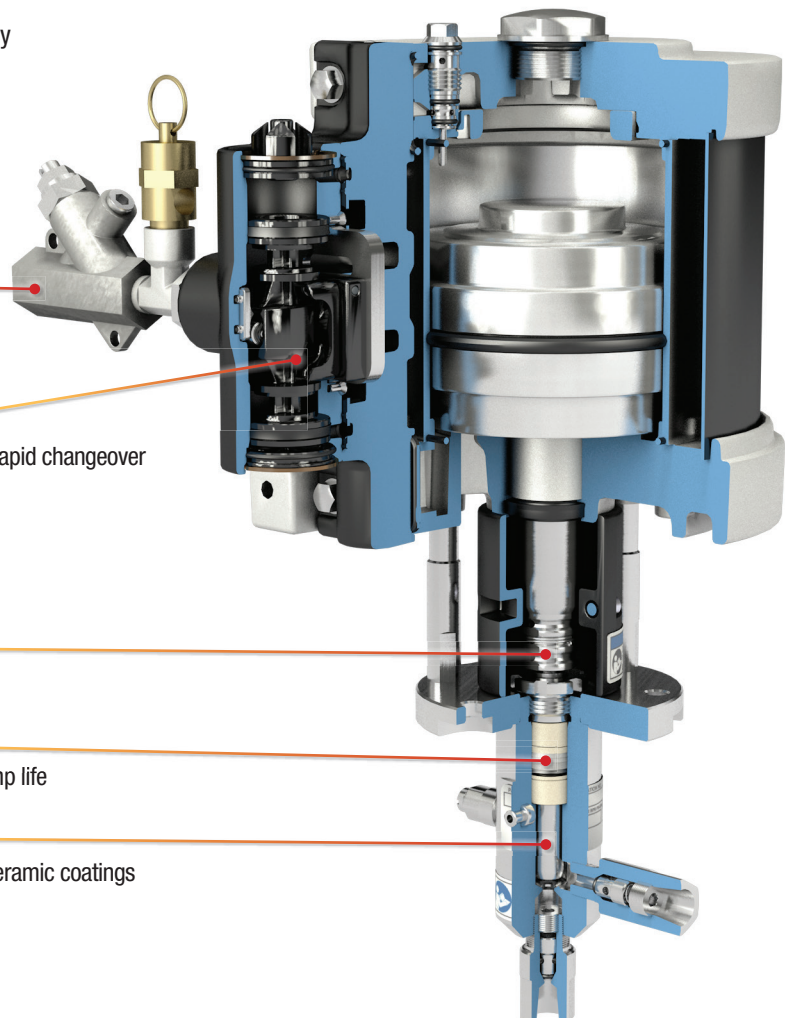

# Selecting the right flows at your given pressures to fit your chemical injection needs.

With three Merkur air motor sizes and up to six different plunger sizes to choose from, the performance table below helps you to quickly identify the right Python XL pump needed for your application.

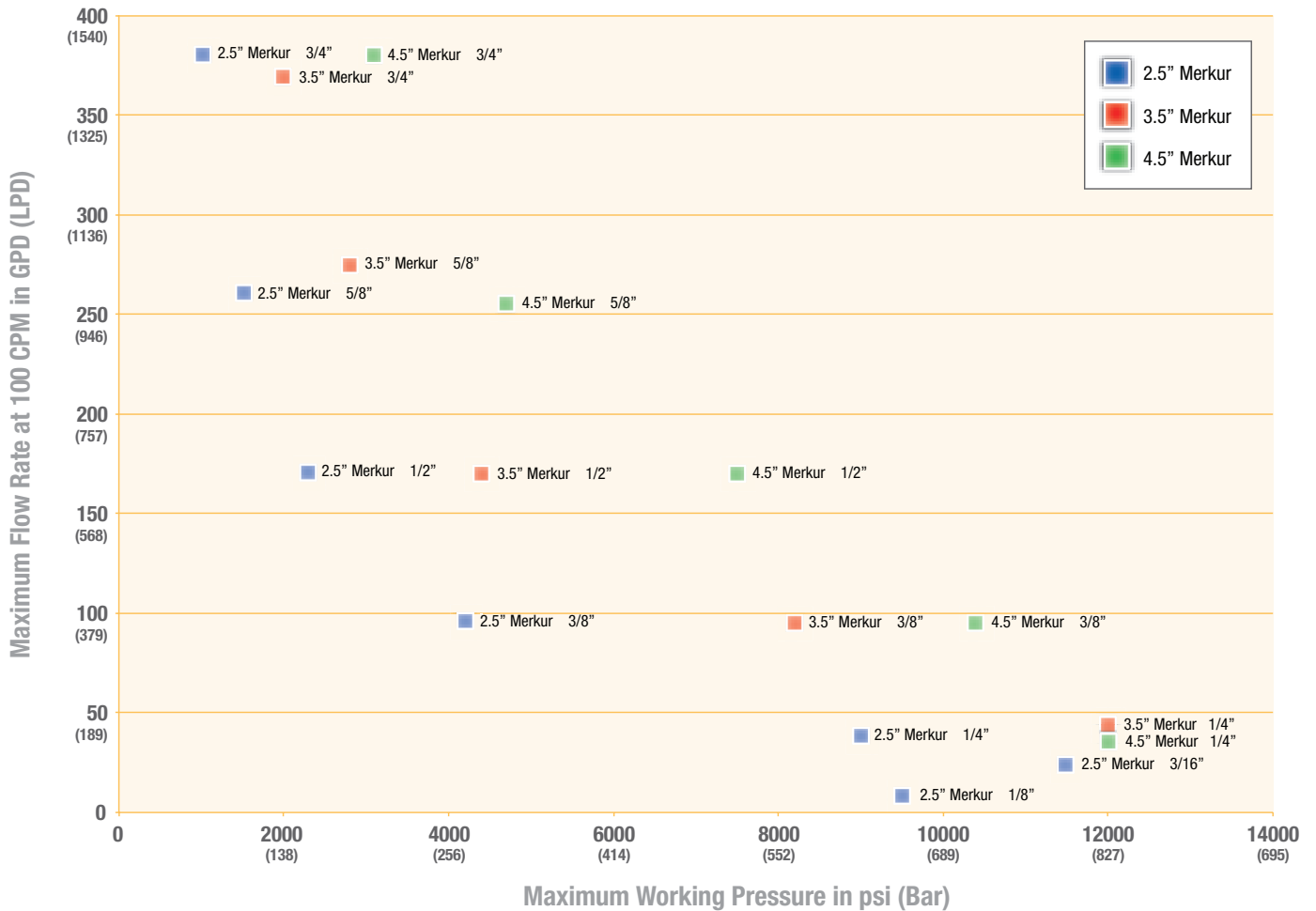

# Ordering Information



GRACO Python XL Pneumatic Pump Model Numbers 2.5"							
Seals / Plunger Size	1/8"	3/16"	1/4"	3/8"	1/2"	5/8"	3/4"
<b>Python XL, Chromex Coated Plungers (CE Certified)</b>							
FKM	A25250	A25255	A25200	A25201	A25202	A25203	A25204
FKM-ETP	A25251	A25256	A25205	A25206	A25207	A25208	A25209
HNBR	A25252	A25257	A25210	A25211	A25212	A25213	A25214
FFKM	A25253	A25258	A25215	A25216	A25217	A25218	A25219
TFE/P	A25254	A25259	A25240	A25241	A25242	A25243	A25244
<b>Python XL, Ceramic Coated Plungers (CE Certified)</b>							
FKM	A25260	A25265	A25220	A25221	A25222	A25223	A25224
FKM-ETP	A25261	A25266	A25225	A25226	A25227	A25228	A25229
HNBR	A25262	A25267	A25230	A25231	A25232	A25233	A25234
FFKM	A25263	A25268	A25235	A25236	A25237	A25238	A25239
TFE/P	A25264	A25269	A25245	A25246	A25247	A25248	A25249
<b>Python XL, Chromex Coated Plungers (ATEX Certified)</b>							
FKM	A25550	A25555	A25500	A25501	A25502	A25503	A25504
FKM-ETP	A25551	A25556	A25505	A25506	A25507	A25508	A25509
HNBR	A25552	A25557	A25510	A25511	A25512	A25513	A25514
FFKM	A25553	A25558	A25515	A25516	A25517	A25518	A25519
TFE/P	A25554	A25559	A25540	A25541	A25542	A25543	A25544
<b>Python XL, Ceramic Coated Plungers (ATEX Certified)</b>							
FKM	A25560	A25565	A25520	A25521	A25522	A25523	A25524
FKM-ETP	A25561	A25566	A25525	A25526	A25527	A25528	A25529
HNBR	A25562	A25567	A25530	A25531	A25532	A25533	A25534
FFKM	A25563	A25568	A25535	A25536	A25537	A25538	A25539
TFE/P	A25564	A25569	A25545	A25546	A25547	A25548	A25549

## Common Pump Parts and Kits Ordering Information

Kit No.	Item Description	Kit No.	Item Description
B32274	Stand Leg Kit	B32191	Priming Bleed Valve, low pressure
B32272	Wall Bracket 2.5", 3.5" Merkur	B32250	Priming Bleed Valve, high pressure
B32253	Needle Valve Kit (110 psi safety valve)	B32273	Air Motor Tie Rod

For additional parts and kits, refer to Python XL instruction manual 3A3948, pages 36, 37, 38 and 43



B32302  
Pump Lower Kit  
1/2" Chromex Plunger



B32256  
1/2" Chromex Plunger



B32270  
Larger Adapter  
Plate Kit



B32264  
1/4" Packing Nut Kit



B32266  
1/2" Packing Nut Kit

### Key Points

- All pumps feature 1/4 in. npt(f) inlet connections.
- Kit B32240 can be used to convert an HF4 outlet connection to a 1/4 in. npt(f) for applications at or under 10,000 psi (689 bar).



GRACO Python XL Pneumatic Pump Model Numbers 3.5"					
Seals / Plunger Size	1/4"	3/8"	1/2"	5/8"	3/4"
Python XL, Chromex Coated Plungers (CE Certified)					
FKM	A25300	A25301	A25302	A25303	A25304
FKM-ETP	A25305	A25306	A25307	A25308	A25309
HNBR	A25310	A25311	A25312	A25313	A25314
FFKM	A25315	A25316	A25317	A25318	A25319
TFE/P	A25380	A25381	A25382	A25383	A25384
Python XL, Ceramic Coated Plungers (CE Certified)					
FKM	A25320	A25321	A25322	A25323	A25324
FKM-ETP	A25325	A25326	A25327	A25328	A25329
HNBR	A25330	A25331	A25332	A25333	A25334
FFKM	A25335	A25336	A25337	A25338	A25339
TFE/P	A25385	A25386	A25387	A25388	A25389
Python XL, Chromex Coated Plungers (ATEX Certified)					
FKM	A25340	A25341	A25342	A25343	A25344
FKM-ETP	A25345	A25346	A25347	A25348	A25349
HNBR	A25350	A25351	A25352	A25353	A25354
FFKM	A25355	A25356	A25357	A25358	A25359
TFE/P	A25390	A25391	A25392	A25393	A25394
Python XL, Ceramic Coated Plungers (ATEX Certified)					
FKM	A25360	A25361	A25362	A25363	A25364
FKM-ETP	A25365	A25366	A25367	A25368	A25369
HNBR	A25370	A25371	A25372	A25373	A25374
FFKM	A25375	A25376	A25377	A25378	A25379
TFE/P	A25395	A25396	A25397	A25398	A25399

GRACO Python XL Pneumatic Pump Model Numbers 4.5"					
Seals / Plunger Size	1/4"	3/8"	1/2"	5/8"	3/4"
Python XL, Chromex Coated Plungers (CE Certified)					
FKM	A25400	A25401	A25402	A25403	A25404
FKM-ETP	A25405	A25406	A25407	A25408	A25409
HNBR	A25410	A25411	A25412	A25413	A25414
FFKM	A25415	A25416	A25417	A25418	A25419
TFE/P	A25440	A25441	A25442	A25443	A25444
Python XL, Ceramic Coated Plungers (CE Certified)					
FKM	A25420	A25421	A25422	A25423	A25424
FKM-ETP	A25425	A25426	A25427	A25428	A25429
HNBR	A25430	A25431	A25432	A25433	A25434
FFKM	A25435	A25436	A25437	A25438	A25439
TFE/P	A25445	A25446	A25447	A25448	A25449
Python XL, Chromex Coated Plungers (ATEX Certified)					
FKM	A25800	A25801	A25802	A25803	A25804
FKM-ETP	A25805	A25806	A25807	A25808	A25809
HNBR	A25810	A25811	A25812	A25813	A25814
FFKM	A25815	A25816	A25817	A25818	A25819
TFE/P	A25840	A25841	A25842	A25843	A25844
Python XL, Ceramic Coated Plungers (ATEX Certified)					
FKM	A25820	A25821	A25822	A25823	A25824
FKM-ETP	A25825	A25826	A25827	A25828	A25829
HNBR	A25830	A25831	A25832	A25833	A25834
FFKM	A25835	A25836	A25837	A25838	A25839
TFE/P	A25845	A25846	A25847	A25848	A25849



# Python® XL-DA Pneumatically Operated Pumps

## Features and Benefits

Python XL-DA series pumps are suitable for chemical injection applications that require higher flows at high pressures. These pumps operate on low gas or compressed air pressures and utilize the same Merkur® air motor used on other Graco products. The Graco patented high efficiency air valve helps minimize fugitive emissions and gas recovery can be achieved on specific models. The Python XL-DA pumps fluid in both stroke directions which provides continuous flow operation and prevents the pump from air locking.

### Double Acting

- Pumps fluid in both directions of the stroke for increased flows
- Provides continuous flow operation for better pump efficiencies

### Self Priming

- Anti-locking so air cannot get trapped inside air motor and stall pump
- Pump can free itself of air and resume pumping without any adjustments

### Ease of Serviceability

- Simple pump design for quick seals replacement
- Pumps are installed vertically for a reduced footprint
- Minimum number of tools required

### Environmentally friendly

- Recoverable exhaust gas with kit
- Less fugitive emissions
- 4.5" air motors come ready for a gas recovery add-on kit

### Adjustable Packing Seals

For better sealing and increased pump life

### Plunger Rod Design

- Chromex coated plunger comes standard
- Ceramic coated plunger available as an option
- Drive cylinder also coated

### Poppet Style Check Valves

Proprietary design

### Hollow Pump Rod Design

Allows for flow in both directions of stroke

### Self Priming Double Acting Pump Lower

- Double the flow
- Check valves not required
- Can better handle viscous materials

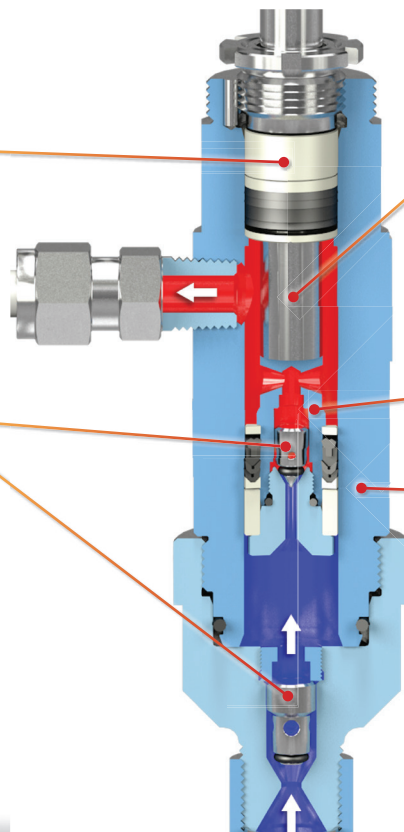

# Ordering Information

GRACO Python XL-DA Pneumatic Pump Model Numbers 2.5"			
Seals / Plunger Size	3/8"	1/2"	3/4"
Python XL-DA, Chromex Coated Plungers (CE Approved)			
HNBR	A22200	A22206	A22212
FFKM	A22201	A22207	A22213
TFE/P	A22202	A22208	A22214
Python XL-DA, Ceramic Coated Plungers (CE Approved)			
HNBR	A22203	A22209	A22215
FFKM	A22204	A22210	A22216
TFE/P	A22205	A22211	A22217

GRACO Python XL-DA Pneumatic Pump Model Numbers 2.5"			
Seals / Plunger Size	3/8"	1/2"	3/4"
Python XL-DA, Chromex Coated Plungers (ATEX Approved)			
HNBR	A24200	A24206	A24212
FFKM	A24201	A24207	A24213
TFE/P	A24202	A24208	A24214
Python XL-DA, Ceramic Coated Plungers (ATEX Approved)			
HNBR	A24203	A24209	A24215
FFKM	A24204	A24210	A24216
TFE/P	A24205	A24211	A24217

GRACO Python XL-DA Pneumatic Pump Model Numbers 3.5"				
Seals / Plunger Size	3/8"	1/2"	3/4"	1"
Python XL-DA, Chromex Coated Plungers (CE Approved)				
HNBR	A22300	A22306	A22312	A22318
FFKM	A22301	A22307	A22313	A22319
TFE/P	A22302	A22308	A22314	A22320
Python XL-DA, Ceramic Coated Plungers (CE Approved)				
HNBR	A22303	A22309	A22315	A22321
FFKM	A22304	A22310	A22316	A22322
TFE/P	A22305	A22311	A22317	A22323

GRACO Python XL-DA Pneumatic Pump Model Numbers 3.5"				
Seals / Plunger Size	3/8"	1/2"	3/4"	1"
Python XL-DA, Chromex Coated Plungers (ATEX Approved)				
HNBR	A24300	A24306	A24312	A24318
FFKM	A24301	A24307	A24313	A24319
TFE/P	A24302	A24308	A24314	A24320
Python XL-DA, Ceramic Coated Plungers (ATEX Approved)				
HNBR	A24303	A24309	A24315	A24321
FFKM	A24304	A24310	A24316	A24322
TFE/P	A24305	A24311	A24317	A24323

GRACO Python XL-DA Pneumatic Pump Model Numbers 4.5"			
Seals / Plunger Size	1/2"	3/4"	1"
Python XL-DA, Chromex Coated Plungers (CE Approved)			
HNBR	A22406	A22412	A22418
FFKM	A22407	A22413	A22419
TFE/P	A22408	A22414	A22420
Python XL-DA, Ceramic Coated Plungers (CE Approved)			
HNBR	A22409	A22415	A22421
FFKM	A22410	A22416	A22422
TFE/P	A22411	A22417	A22423

GRACO Python XL-DA Pneumatic Pump Model Numbers 4.5"			
Seals / Plunger Size	1/2"	3/4"	1"
Python XL-DA, Chromex Coated Plungers (ATEX Approved)			
HNBR	A24406	A24412	A24418
FFKM	A24407	A24413	A24419
TFE/P	A24408	A24414	A24420
Python XL-DA, Ceramic Coated Plungers (ATEX Approved)			
HNBR	A24409	A24415	A24421
FFKM	A24410	A24416	A24422
TFE/P	A24411	A24417	A24423



Python XL-DA 2.5"



Python XL-DA 3.5"



Python XL-DA 4.5"

# Python® XL-DA25

## Features and Benefits

The Python XL-DA25 combines all of the benefits of a Graco pneumatic chemical pump including stainless steel wetted parts, a signature Merkur air motor, and ease of serviceability with the benefits of a Python XL-DA including double acting, self-priming, and environmentally friendly. The Python XL-DA25 can achieve a max flow rate up to 1 GPM (3.79 LPM) making it suitable for offshore and high flow applications.

## Ordering Information

GRACO Python XL-DA25 Pump Model Numbers, 6" Merkur		
Seals / Plunger Size	3/4"	1"
CE Approved		
HNBR	A22606	A22612
FFKM	A22607	A22613
TFE/P	A22608	A22614
ATEX Approved		
HNBR	A24606	A24612
FFKM	A24607	A24613
TFE/P	A24608	A24614

GRACO Python XL-DA25 Pump Model Numbers, 7.5" Merkur		
Seals / Plunger Size	3/4"	1"
CE Approved		
HNBR	A22706	A22712
FFKM	A22707	A22713
TFE/P	A22708	A22714
ATEX Approved		
HNBR	A24706	A24712
FFKM	A24707	A24713
TFE/P	A24708	A24714



# Performance Curves

KEY	
Inlet Pressure	
A	= 15 psi (0.10 bar)
B	= 25 psi (0.17 bar)
C	= 50 psi (0.34 bar)
D	= 75 psi (0.52 bar)
E	= 100 psi (0.69 bar)
---	Fluid Flow
--	Air Flow

## 6" Motors

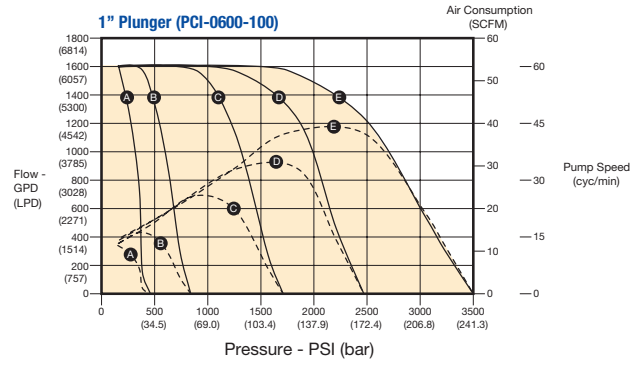
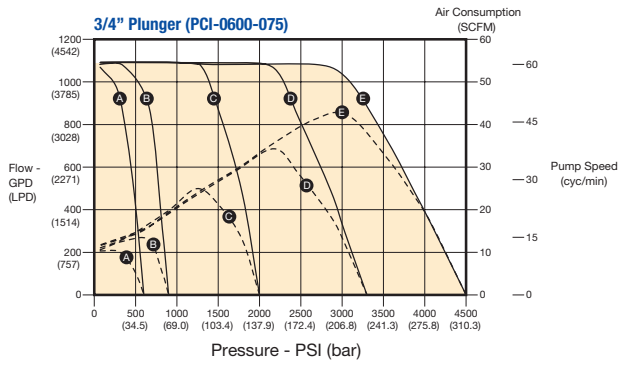

## 7.5" Motors

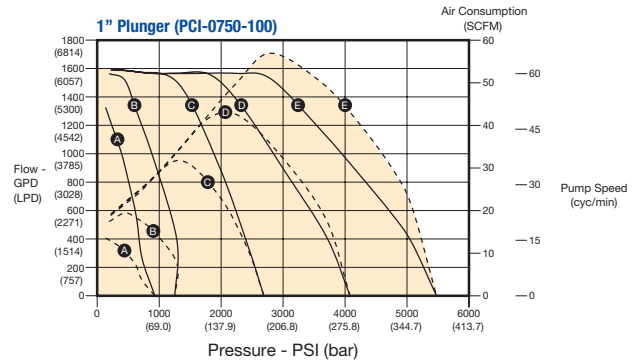
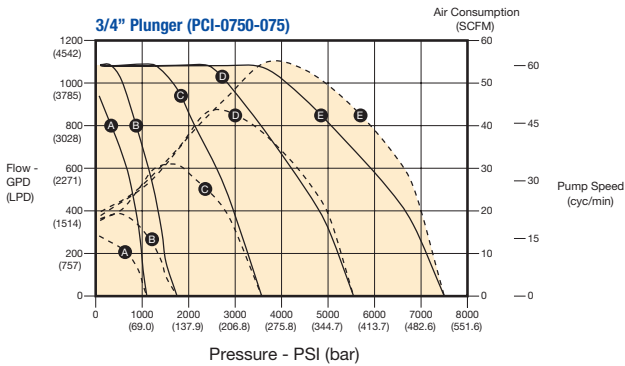



## ABOUT GRACO

### PROVEN QUALITY. LEADING TECHNOLOGY.

Founded in 1926, Graco is a world leader in fluid handling systems and components. Graco products move, measure, control, dispense and apply a wide range of fluids and viscous materials used in vehicle lubrication, commercial and industrial settings.

The company's success is based on its unwavering commitment to technical excellence, world-class manufacturing and unparalleled customer service. Working closely with qualified distributors, Graco offers systems, products and technology that set the quality standard in a wide range of fluid handling solutions. Graco provides equipment for spray finishing, protective coating, paint circulation, lubrication, and dispensing sealants and adhesives, along with power application equipment for the contractor industry. Graco's ongoing investment in fluid management and control will continue to provide innovative solutions to a diverse global market.



**MJ Systems, LLC**

**Authorized Graco Distributors**

TX - Off (281) 842-7600

LA - Off (504) 264-7744

[www.mjsusa.com](http://www.mjsusa.com) • [sales@mjsusa.com](mailto:sales@mjsusa.com)