



Chemical Injection

Wolverine® AC and DC Operated Variable Speed Pumps



MJ Systems, LLC
Authorized Graco Distributors

TX - Off (281) 842-7600

LA - Off (504) 264-7744

www.mjsusa.com • sales@mjsusa.com



PROVEN QUALITY. LEADING TECHNOLOGY.

Wolverine® Variable Speed Pumps

Features and Benefits

The variable speed Wolverine pump provides continuous injection for an even dispersion of chemicals.

Pump Capabilities

Flow rates are adjusted between 10 and 100% by a control dial on the motor eliminating the need for a localized controllers. The fluid heads are interchangeable between all Wolverine Advanced series pumps.

Motor

High efficiency 12 or 24VDC brushless motors use less amperage draw than traditional brushed DC motors. This helps eliminate the need for extra batteries and solar panels in solar powered chemical injection systems. The DC motors are rated for use in Hazardous (Classified) Locations. The AC motors are rated for ordinary location.*

* Power inverters available for AC motors. Please see B32717 and B32718 in the Buyer's Guide

Accurate Control

Precision stroke adjustment between 1/4 in to 1 in (6.4 mm to 25.4 mm) ensures accurate injection rates.

Chemical Compatibility

HNBR, FKM, FKM-ETP, and FFKM plunger packings and check valve seals can handle some of the most aggressive chemicals.

Standards

The DC operated motors are rated for use in Division 2 Hazardous (Classified) Locations per the following standards.





Class I, Group A & B,
Class II, Group C & D



Class I, Group A & B,
Class II, Group C & D



Wolverine Variable Speed Duplex

Models	Voltage	Motor	Plunger Size	Maximum Working Pressure psi (MPa, bar)	Motor Approvals
A281xx	12 VDC	Variable Speed Brushless	3/16 in.	10,000 (69.0, 690)	 Class I, Division 2 Groups A, B, C, D
			1/4 in.	6000 (41.3, 413)	
			3/8 in.	2500 (17.2, 172)	
			1/2 in.	1250 (8.6, 86)	
			5/8 in.	900 (6.2, 62)	
			3/4 in.	600 (4.1, 41)	
A283xx	24 VDC	Variable Speed Brushless	3/16 in.	10,000 (69.0, 690)	 Class I, Division 2 Groups A, B, C, D
			1/4 in.	6000 (41.3, 413)	
			3/8 in.	2500 (17.2, 172)	
			1/2 in.	1250 (8.6, 86)	
			5/8 in.	900 (6.2, 62)	
			3/4 in.	600 (4.1, 41)	
A285xx	115 VAC	Variable Speed AC	3/16 in.	10,000 (69.0, 690)	
			1/4 in.	6000 (41.3, 413)	
			3/8 in.	2500 (17.2, 172)	
			1/2 in.	1250 (8.6, 86)	
			5/8 in.	900 (6.2, 62)	
			3/4 in.	600 (4.1, 41)	

Ordering Information

Wolverine Variable Speed, 12 VDC, 1/5 hp, Simplex			
Seals / Plunger Size	1/4"	3/8"	1/2"
FKM	A28102	A28101	A28100
HNBR	A28116	A28115	A28114
FFKM	A28123	A28122	A28121

Wolverine Variable Speed, 12 VDC, 1/5 hp, Duplex			
Seals / Plunger Size	1/4"	3/8"	1/2"
FKM	A28130	A28129	A28128
HNBR	A28144	A28143	A28142
FFKM	A28151	A28150	A28149

Wolverine Variable Speed, 24 VDC, 1/5 hp, Simplex			
Seals / Plunger Size	1/4"	3/8"	1/2"
FKM	A28302	A28301	A28300
HNBR	A28316	A28315	A28314
FFKM	A28323	A28322	A28321

Wolverine Variable Speed, 24 VDC, 1/5 hp, Duplex			
Seals / Plunger Size	1/4"	3/8"	1/2"
FKM	A28330	A28329	A28328
HNBR	A28344	A28343	A28342
FFKM	A28351	A28350	A28349

Wolverine Variable Speed, 115 VAC, 1/5 hp, Simplex			
Seals / Plunger Size	1/4"	3/8"	1/2"
FKM	A28502	A28501	A28500
HNBR	A28516	A28515	A28514
FFKM	A28523	A28522	A28521

Wolverine Variable Speed, 115 VAC, 1/5 hp, Duplex			
Seals / Plunger Size	1/4"	3/8"	1/2"
FKM	A28530	A28529	A28528
HNBR	A28544	A28543	A28542
FFKM	A28551	A28550	A28549

Wolverine Variable Speed Fluid Modules with Chromex Coated Plunger Rods						
Seals / Plunger Size	3/16"	1/4"	3/8"	1/2"	5/8"	3/4"
FKM	A30300	A30400	A30500	A30600	A30700	A30800
HNBR	A30302	A30402	A30502	A30602	A30702	A30802
FKM-ETP	A30301	A30401	A30501	A30601	A30701	A30801
FFKM	A30303	A30403	A30503	A30603	A30703	A30803

Wolverine Variable Speed Fluid Modules with Ceramic Coated Plunger Rods						
Seals / Plunger Size	3/16"	1/4"	3/8"	1/2"	5/8"	3/4"
FKM	A30310	A30410	A30510	A30610	A30710	A30810
HNBR	A30312	A30412	A30512	A30612	A30712	A30812
FKM-ETP	A30311	A30411	A30511	A30611	A30711	A30811
FFKM	A30313	A30413	A30513	A30613	A30713	A30813

Wolverine Variable Speed Drive Modules, 12 VDC, 1/11 Hp Motor						
	Simplex (50)	Simplex (70)	Duplex (55)	Duplex (75)	Duplex (57)	Duplex (77)
12 VAC	A30200	A30203	A30201	A30204	A30202	A30205
24 VAC	A30210	A30213	A30211	A30214	A30212	A30215
115 VAC	A30260	A30263	A30261	A30264	A30262	A30265

(50) Used for simplex pumps with 1/4", 3/8" and 1/2" plunger sizes.

(70) Used for simplex pumps with 3/16", 5/8" and 3/4" plunger sizes.

(55) Used for duplex pumps with 1/4", 3/8" and 1/2" plunger sizes.

(77) Used for duplex pumps with 3/16", 5/8" and 3/4" plunger sizes.

(57) Used for duplex pumps with 1/4", 3/8" and 1/2" plunger sizes on one side and 3/16", 5/8" and 3/4" plunger sizes on the opposite side.

(75) Used for duplex pumps with 3/16", 5/8" and 3/4" plunger sizes on one side and 1/4", 3/8" and 1/2" plunger sizes on the opposite side.

Dimensions

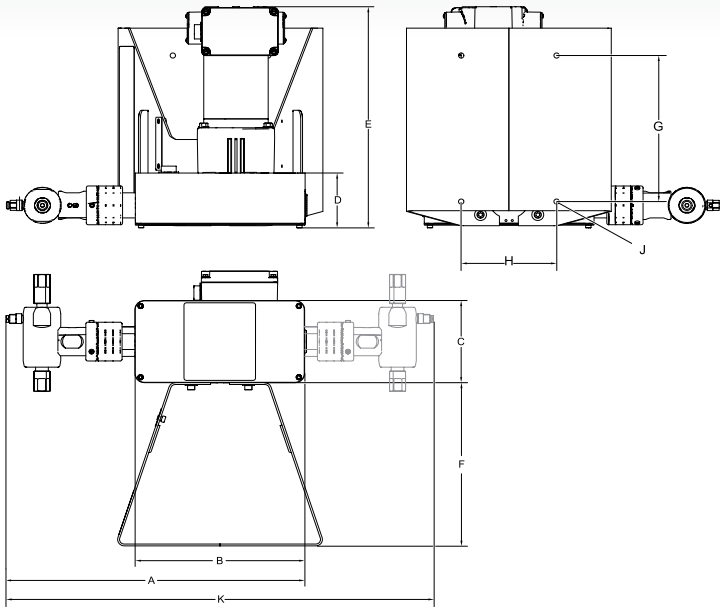

A	B	C	D	E	F	G	H	J	K
16.3 in. (41.4 cm)	8.9 in. (22.6 cm)	4.5 in. (11.4 cm)	2.85 in. (7.2 cm)	11.9 in. (30.2 cm)	8.9 in. (22.7 cm)	8.0 in. (20.3 cm)	5.0 in. (12.7 cm)	0.281 in. dia (0.714 cm)	23.7 in. (60.2 cm)

Configurations

Fluid Plunger Sizes

- 3/16 in (4.76 mm)
- 1/4 in (6.35 mm)
- 3/8 in (9.5 mm)
- 1/2 in (12.7 mm)
- 5/8 in (15.9 mm)
- 3/4 in (19.1 mm)

Drivetrain

- Simplex
- Duplex

Input Power Types

- 12 VDC
- 24 VDC
- 115 VAC

Electric Motor Sizes

- 1/5 hp (VDC)
- 1/5 hp (VAC)

Motor Frequency

- Variable

Performance Curves

KEY	
B-DC	Advanced Simplex
C-DC	Advanced Duplex
D-AC	Advanced Simplex
E-AC	Advanced Duplex

3/16 Inch Plunger

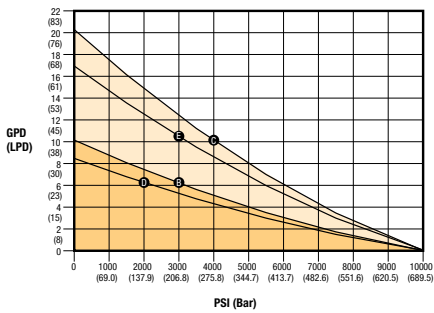

3/8 Inch Plunger

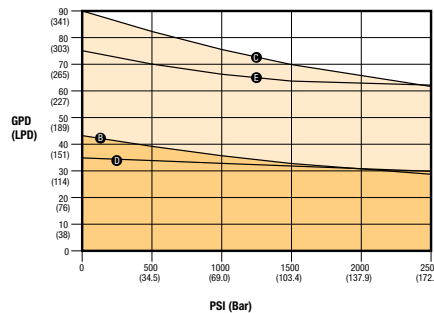

5/8 Inch Plunger

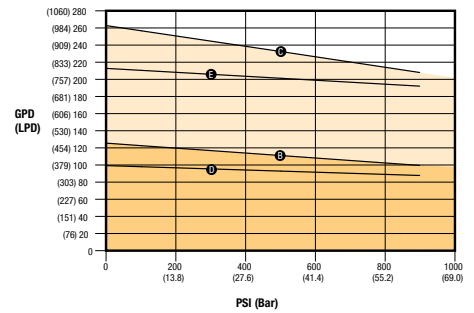

1/4 Inch Plunger

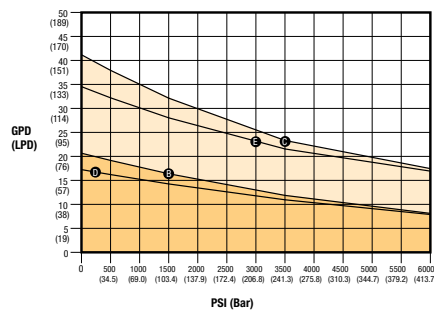

1/2 Inch Plunger

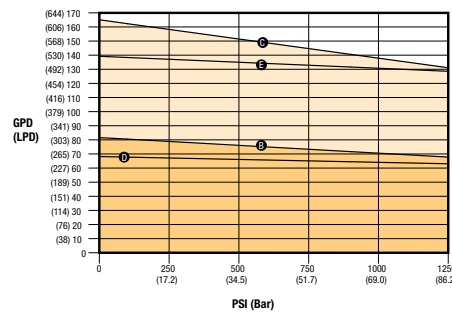

3/4 Inch Plunger

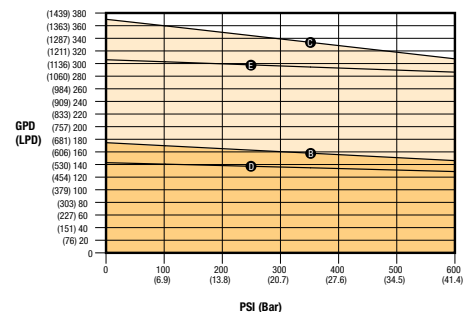

All written and visual data contained in this document are based on the latest product information available at the time of publication. Graco reserves the right to make changes at any time without notice.



MJ Systems, LLC
Authorized Graco Distributors
 TX - Off (281) 842-7600
 LA - Off (504) 264-7744
SYSTEMS www.mjsusa.com • sales@mjsusa.com

